

LEFT SIDE VIEW

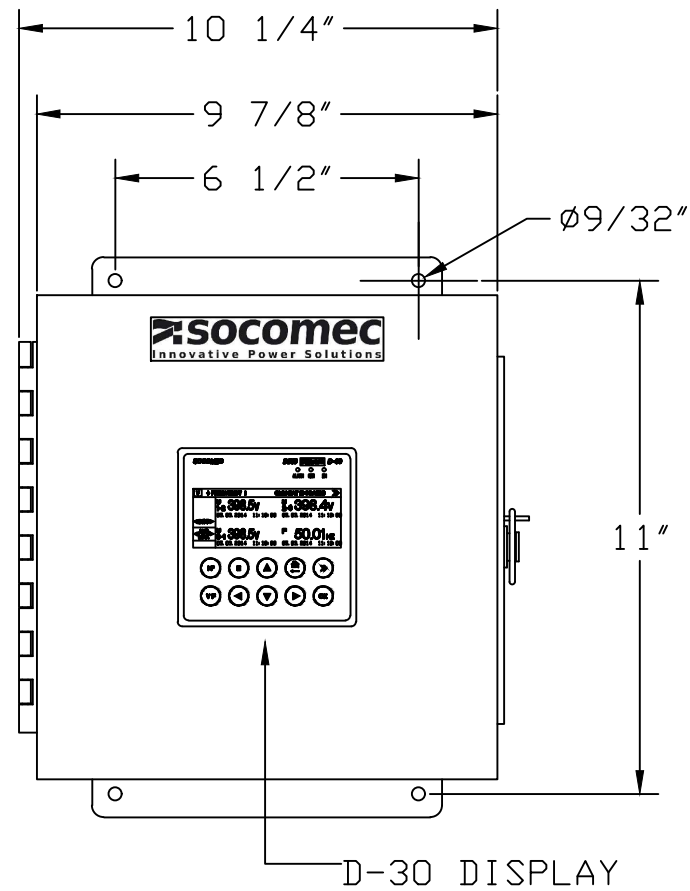

FRONT VIEW

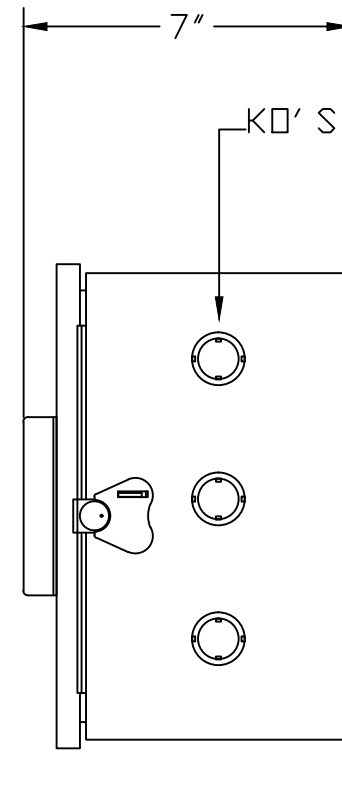

RIGHT SIDE VIEW

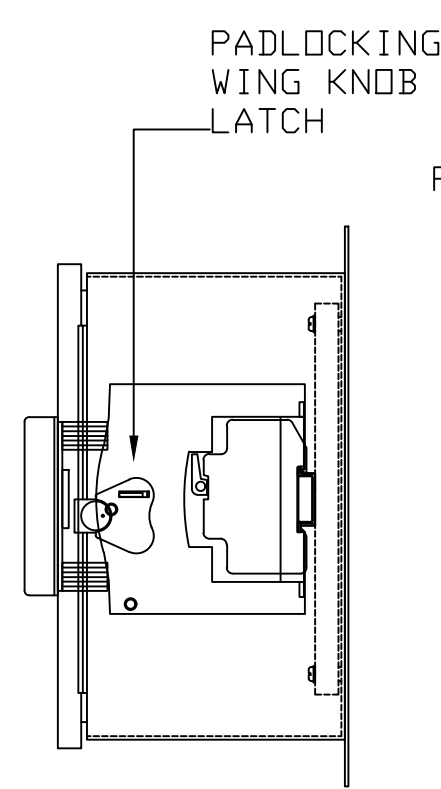

RIGHT SIDE VIEW CUTAWAY

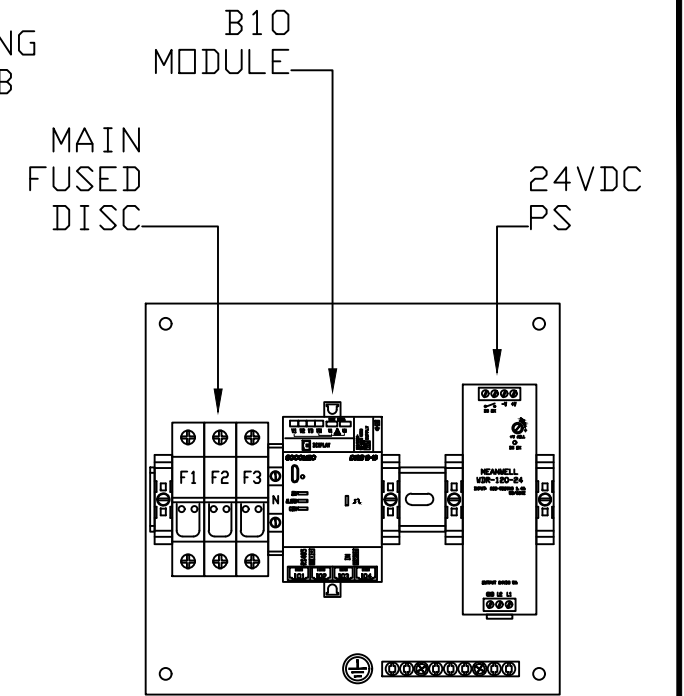

SUBPLATE LAYOUT

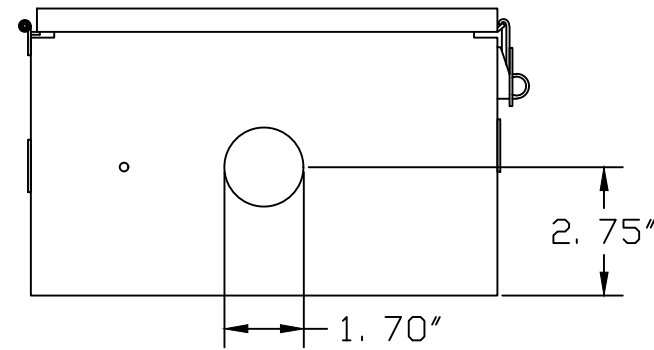

BOTTOM VIEW

- NOTES:
 1- TYPE 1 ENCLOSURE.
 2- 14GA STEEL CONSTRUCTION.
 3- POWDER COATED, COLOR ANSI 49 GREY.

PART NUMBER:	DBB01D30
DESCRIPTION:	B10, D30 DISPLAY AND 24VDC PS
PROJECT:	SOCOMEK METERING PANELS - DIGIBOX-1 STYLE
CUSTOMER:	XXXX
ADDRESS:	XXXX
ADDRESS:	XXXX



DRAWING:	SOCOMEK METERING PANELS - DIGIBOX-1 STYLE - # DBB01D30
SCALE:	NONE
DATE:	8-22-2017 (REV-0)
DRAWN BY:	LPC
CHECKED BY:	APN
DRAWING #:	SOCOMEK METERING PANELS - DIGIBOX-1 STYLE - # DBB01D30 - M1

REVISIONS	
REV-6	
REV-5	
REV-4	
REV-3	
REV-2	
REV-1	ADDED DIMS AND CHANGED TITLE 10-5-17 / LPC